

propellor

Homespun



Homespun is Propellor's take on the classic spun metal light. We've had the metal work done close to home, working with a metal spinner in our city. Spun by experienced hands, Homespun lights bear subtle traces of the tool grooves worn during the spinning process.

This light is all about colour. Let us know what palette of colours you are working with and we will customise Homespun for your space.

www.propellor.ca 1247 Cartwright Street, Vancouver, BC 604 682 6665 studio@propellor.ca

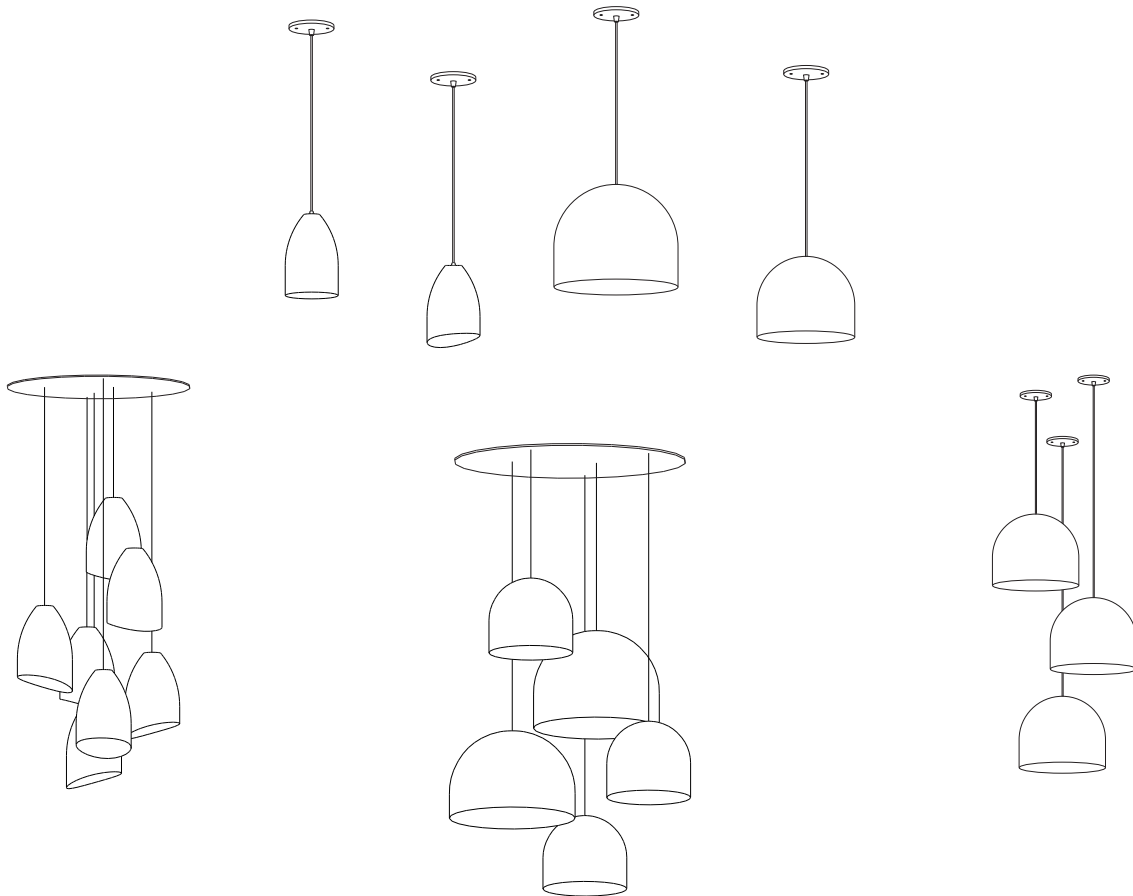

HOMESPUN PENDANT LIGHT

Description:

Spun metal pendant light, fully customisable to project colour or material palette

Details:

Shade: spun aluminum or copper, available in white or custom colours

Canopy: junction box mounted in white, silver or black

Cord: black or white, custom fabric covered cord available

Also available: multiple pendant configurations on a single ceiling mounted canopy

Lamp Type:

Homespun 6.5: med. base 120V, 15W A19 dimmable LED provided. 1600 lumens, 3000K

Homespun 12, 18 & 30: medium base 120V, 12W G40 dimmable LED. 950 lumens, 3000K

Regulatory Compliance:

All products are inspected and accepted by QAI Laboratories or CSA International prior to shipment.

Final acceptance of the approval mark is subject to the requirements of the local Authority Having Jurisdiction.

Homespun 6.5 - straight edge

Dimensions: 6.5"Ø x 10" tall
 Drop: 60" standard or to specification
 Lamping: 1 x medium base 20W max. Dimmable LED provided
 Weight: 2lb / .9kg
 Custom sizes and configurations available
 Typical lead time: 3-6 weeks
 Prices: **HS6.5_W** powder coated white: \$445 CAD
HS6.5_1 white interior, custom exterior: \$615 CAD
HS6.5_2 custom interior, custom exterior: \$765 CAD
HS6.5_C copper \$763 CAD
HS6.5_CI copper interior, custom exterior: \$880 CAD

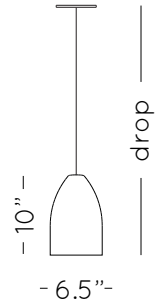

Homespun 6.5 - beveled edge

Dimensions: 6.5"Ø x 10" tall
 Drop: 60" standard or to specification
 Lamping: 1 x medium base 20W max. Dimmable LED provided
 Weight: 2lb / .9kg
 Custom sizes and configurations available
 Typical lead time: 3-6 weeks
 Prices: **HS6.5B_W** powder coated white: \$515 CAD
HS6.5B_1 white interior, custom exterior: \$685 CAD
HS6.5B_2 custom interior, custom exterior: \$840 CAD
HS6.5B_C copper: \$835 CAD
HS6.5B_CI copper interior, custom exterior: \$985 CAD

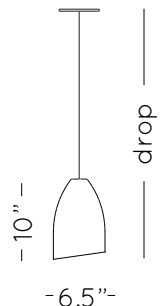

Homespun 12

Dimensions: 12"Ø x 10" tall
 Drop: 60" standard or to specification
 Lamping: 1 x medium base 20W max. Dimmable globe LED provided
 Weight: 3lb / 1.4kg
 Custom sizes and configurations available
 Typical lead time: 3-6 weeks
 Prices: **HS12_W** powder coated white: \$662 CAD
HS12_1 white interior, custom exterior: \$958 CAD
HS12_2 custom interior, custom exterior: \$1035 CAD
HS12_C copper: \$1215 CAD
HS12_CI copper interior, custom exterior: \$1565 CAD

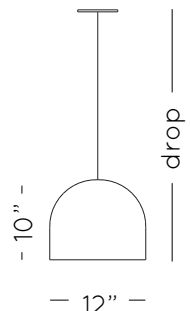

Homespun 18

Dimensions: 18"Ø x 15" tall
 Drop: 60" standard or to specification
 Lamping: 1 x medium base 20W max. Dimmable globe LED provided
 Weight: 6.2lb / 2.81kg
 Custom sizes and configurations available
 Typical lead time: 3-6 weeks
 Prices: **HS18_W** powder coated white: \$763 CAD
HS18_1 white interior, custom exterior: \$1060 CAD
HS18_2 custom interior, custom exterior: \$1165 CAD
HS18_C copper (17"Ø x 12"): \$1650 CAD
HS18_CI copper interior, custom exterior (17"Ø x 12"): \$1945 CAD

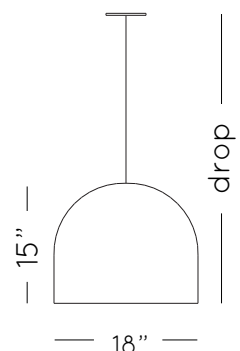

*prices reflect standard models, please contact us for enquiries regarding custom options.

propellor

Standard Configurations

Homespun 30

Dimensions: 29.5"Ø x 15" tall

Drop: 60" standard or to specification

Lamping: 1 x medium base 20W max. Dimmable globe LED provided

Weight: 10lb / 4.54kg

Custom sizes and configurations available

Typical lead time: 3-6 weeks

Prices: **HS30_W** powder coated white: \$2175 CAD

HS30_1 white interior, custom exterior: \$2500 CAD

HS30_2 custom interior, custom exterior: \$2770 CAD

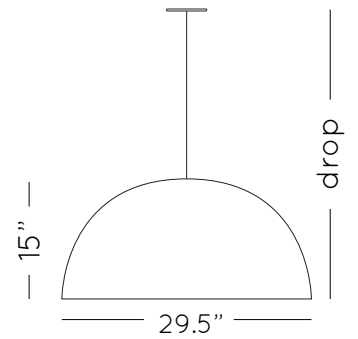

Custom Configurations

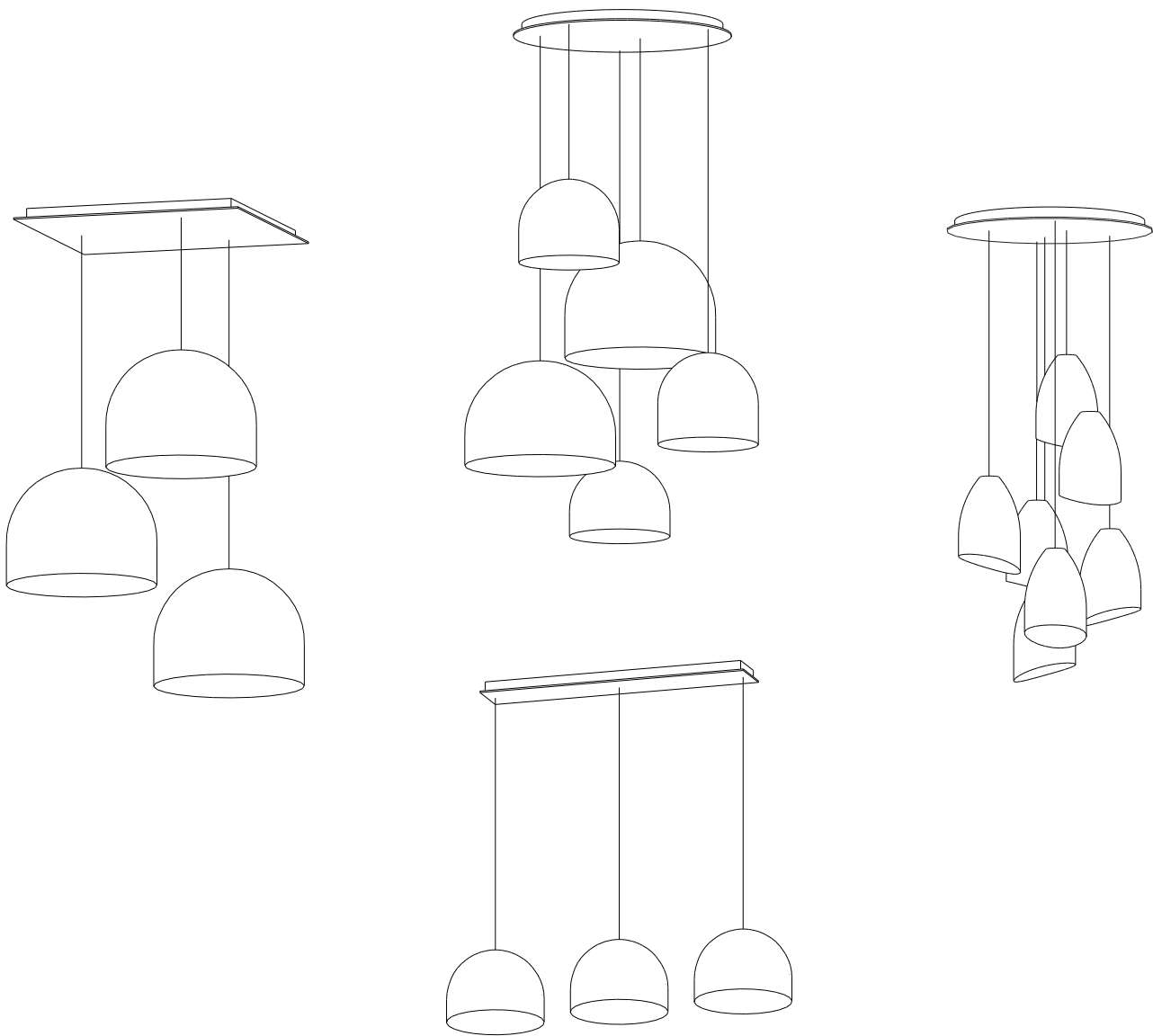

Multiple pendants on a single custom canopy, please enquire for pricing:

www.propellor.ca 1247 Cartwright Street, Vancouver, BC 604 682 6665 studio@propellor.ca